



PowerPlex[®] Keypads Installation and Operating Instructions



Installation Instructions: **PowerPlex**® Keypads

Issue: I_PP-M-KP-E – Index: A

Date of publication: December 2020

Reference document: M_PP-M-KP-E – Index: - / January 2017

Editor:

E-T-A Elektrotechnische Apparate GmbH
Industriestraße 2-8
90518 Altdorf
GERMANY

Phone: +49 (0) 91 87 / 10-0

Facsimile: +49 (0) 91 87 / 10-397

E-Mail: info@e-t-a.com

Web: www.e-t-a.com

Copyright ©2020 E-T-A GmbH

The contents of this document is the property of E-T-A GmbH. No part of this publication must in any we be reproduced or distributed without prior written consent of E-T-A GmbH. Any person acting illegally with regard to this publication can be prosecuted.

Limitation of liability

Although all provisions were taken when creating this document, the editor does not accept any responsibility for errors or omissions or for damages caused by using the information contained in this document. The information contained in this document may be revised at any time without pre-advise.

Brands

All references to software and hardware in this document are generally protected by brands or patents.

© E-T-A GmbH 2020. All rights reserved.

About this manual

This manual describes start-up of the **PowerPlex**[®] keypad series (PP-M-KP100 and PP-M-KP200) in connection with compatible **PowerPlex**[®] components. We assume that all **PowerPlex**[®] compatible components and devices were installed correctly. The instruction is meant to be used by all professional electricians who want to integrate this control panel into an E-T-A **PowerPlex**[®] system. The **PowerPlex**[®] keypads allow easy and intuitive operation and monitoring of the **PowerPlex**[®] installations.

Besides this document further information on the E-T-A **PowerPlex**[®] can be found on E-T-A's Website.

All manuals contain important instructions for connection and safe operation of the **PowerPlex**[®] devices. Safety instructions have to be observed. All users have to be informed about all safety instructions. The documents have to be accessible for the user.

Qualified personnel



The system must only be installed, connected and configured in connection with this document. Installation and operation of the device/system must only be carried out by qualified personnel. With regard to the safety instructions of this documentation, qualified persons are persons authorised to operate devices, systems and circuits according to the standards and rules of safety engineering.

Safety instructions



Please follow the installation and configuration instructions given in this document carefully. Failure to comply may lead to serious damages of the product or the system. E-T-A is unable to accept responsibility for customer or third party liability, warranty claims or damage caused by incorrect installation or improper handling in disregard of the Installation and Operating Instructions.

Contents

| | |
|--|----|
| About this manual | 3 |
| Contents | 5 |
| List of pictures | 6 |
| List of tables | 6 |
| Symbols | 6 |
| 1. Introduction | 7 |
| 2. System components: Overview | 8 |
| 3. PowerPlex [®] system: General | 11 |
| 3.1. PowerPlex [®] Modules | 11 |
| 3.2. <i>PowerPlex</i> [®] CAN Bus | 11 |
| 3.3. Put down the serial number | 12 |
| 3.4. The CAN bus address | 13 |
| 4. General: <i>PowerPlex</i> [®] Keypads | 13 |
| 4.1. Technical data | 14 |
| 4.2. Scope of delivery | 15 |
| 5. Mounting | 15 |
| 5.1. Installation check list | 15 |
| 5.2. Recommended installation site | 15 |
| 5.3. General notes on wiring | 16 |
| 5.4. Required installation dimensions - mounting cut-out | 17 |
| 5.5. Dimensions and space requirements | 18 |
| 5.6. Mounting of the device | 19 |
| 6. Marking of the keypads | 19 |
| 7. Integration of the device in the CAN bus network | 20 |
| 8. Connection to power supply | 21 |
| 9. <i>PowerPlex</i> [®] Configuration Software | 22 |
| 9.1. Computer Requirements | 22 |
| 9.2. Software installation | 22 |
| 10. CAN/USB converter and driver | 23 |
| 11. Important information and safety instructions | 23 |
| Appendix | 24 |
| Notes | 25 |

List of pictures

| | |
|--|----|
| Fig. 1: Exemplary system design of a recreational vehicle | 8 |
| Fig. 2: Exemplary system design – Boat | 8 |
| Fig. 3: Overview of PowerPlex® components | 10 |
| Fig. 4: Two PowerPlex® modules connected via CAN bus cable | 12 |
| Fig. 5: Various PowerPlex® modules connected via serial CAN bus topology | 12 |
| Fig. 6: PowerPlex® Standard Keypads | 13 |
| Fig. 7: Dimensions for the required mounting cut-out | 17 |
| Fig. 8: Dimensions of the different PowerPlex® Keypads..... | 18 |
| Fig. 9: Dimensions for creating a printing template | 19 |
| Fig. 10: Connection of the PowerPlex® components in the CAN bus system | 20 |
| Fig. 11: CAN/USB converter (example: Peak) | 23 |

List of tables

| | |
|--|----|
| Table 1: Symbols used | 6 |
| Table 2: Additional accessories | 10 |
| Table 3: Different PowerPlex® Modules | 11 |
| Table 4: Selection of technical data | 14 |
| Table 5: Installation check list | 15 |
| Table 6: General requirement of the installation site | 16 |
| Table 7: General notes on wiring | 16 |
| Table 8: Mounting of the device | 19 |
| Table 9: Pin assignment on the 4-pole terminal | 19 |
| Table 10: Major properties of the CAN bus cable to be used | 20 |
| Table 11: Requirements of the configuration PC | 22 |
| Table 12: Important information | 23 |

Symbols

The following conventions and symbols will accompany you throughout the entire manual. They are defined as follows:



| | |
|---|---|
|  | Warning You are in a situation which might cause injury. Before working with one of the devices you have to be aware of the risks of electrical circuitries and you ought to be familiar with standard procedures of accident prevention. |
|  | Caution There is a risk in this situation to do something which might cause damage of the devices or data loss. |
|  | Note Here you receive information which might be particularly useful for the application. |

Table 1: Symbols used

1. Introduction

You chose **PowerPlex**[®], a comprehensive, future-oriented on-board system which combines safety, user convenience and reliability. It is a decentralised power distribution and control system, regulating, controlling and monitoring various loads, switches and sensors and connecting them via CAN. All **PowerPlex**[®] modules ensure reliable control and monitoring of the electrical installations on board, either alone or in combination with other **PowerPlex**[®] components. Besides the protection against overcurrent they allow readout of data of the connected level sensors and temperature sensors as well as of shunts.

By means of the **PowerPlex**[®] configuration software, the application-specific logics for power distribution, power control and power monitoring will be defined, stored or adjusted. Communication takes place via the **PowerPlex**[®] CAN, based on SAE J1939.

Thanks to its system properties **PowerPlex**[®] is the perfect solution for smart electrical networks on boats and in vehicles. Typical applications include:

- Buses, special vehicles, mobile homes etc.
- Watercraft, e.g. leisure boats, workboats

Benefits for the OEM

The E-T-A **PowerPlex**[®] system allows switching and controlling of various loads, timer functions, real load status indication, overcurrent protection and wire break detection. Each function can be configured separately to meet the requirements of the loads.

Based on the CAN communication the **PowerPlex**[®] system allows to make individual wiring between load and control unit a thing of the past. The transmission of switch commands and status information is based on the peer-to-peer CAN bus communication. A direct cable connection between the actuator, e.g. a light switch, and the load, e.g. a lamp, is no longer required. The obvious advantages for the OEM include the reduced wiring and production costs as well as a convenient system setup by means of a Windows based configuration software. All control functions of the system are freely configurable with regard to complexity and size of the system. Change or system extension at a later date are also extremely easy.

PowerPlex[®] Scope of operation – **PowerPlex**[®] takes over the following tasks:

- **Distributes the DC 12 V or DC 24 V power supply** to all spots of the boat where loads are installed, such as lighting and heating control, bilge and water pumps, windscreen wiper motors etc.
- **Collects all status information** of all sensors and actuators everywhere in the vehicle, such temperature and tank level measuring points, ON/OFF status signals of the actuators.
- **Switches devices and equipment ON and OFF**, according to selectable, pre-set scenarios, at the touch of a button.
- **Monitors devices and equipment** regarding their out-of-range conditions, indicates possible failures and responds by reversing the pertinent control unit, as e. g. switching on a pump, if the water tank level falls below a certain limit.
- **Protects devices and equipment** against hazardous overcurrent and short circuit by isolating the faulty load from the system and failure indication to the system.
- **Offers back-up protection and switching** in the improbable case of a **PowerPlex**[®] system or component failures.

2. System components: Overview

The **PowerPlex**[®] system of E-T-A is a comprehensive on-board system combining safety, convenience and reliability. **PowerPlex**[®] allows individual and flexible concepts of switching the illumination, acoustic and special signals and lots more. It automatically switches loads and immediately indicates undesired conditions of the devices or of the entire electrical installation. Thus it is ensured, that everything works precisely - which is reassuring, as the loads often are not in plain sight. E-T-A **PowerPlex**[®] is a decentralised power distribution system with electronic protection – clearly reflecting trends of the future.

Fig. 1 and Fig. 2 show typically **PowerPlex**[®] solutions with an application-specific number of **PowerPlex**[®] components - modules and control units – installed at various positions.

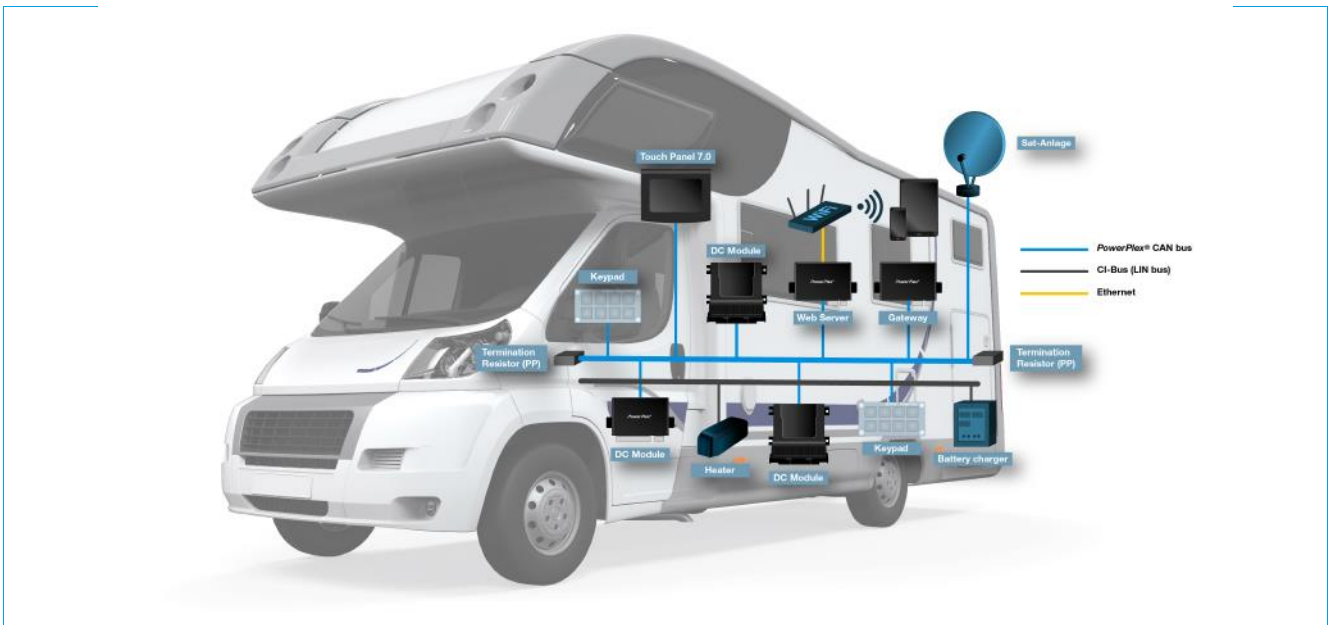

Fig. 1: Exemplary system design of a recreational vehicle

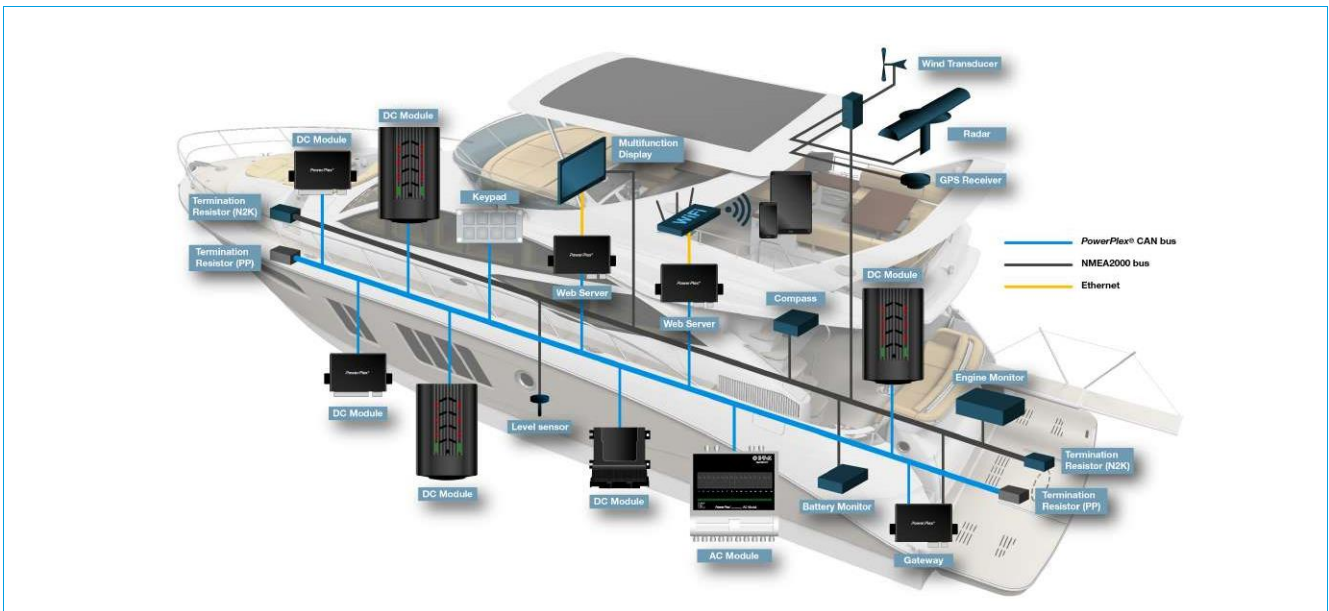

Fig. 2: Exemplary system design – Boat

PowerPlex[®] communication is based on the CAN bus principle by means of “nodes”, which communicate with each other via a serial 2-wire connection. Hence the key components of a **PowerPlex**[®] system are these nodes distributed over the vehicle or boat. The overall **PowerPlex**[®] term for these interconnected nodes is “module”.

Various hardware components are required for installation and start-up of a **PowerPlex**[®] system:

Please check the delivered components upon receipt with regard to completeness. You require the following hardware components for installation and start-up of a **PowerPlex**[®] system:

- one or more **PowerPlex**[®] modules (e. g. DC Power Module, DC Compact Module) allowing for the module-specific requirements
- USB-CAN converters (cable and driver) for transferring the configuration.
- USB cables for the USB service interface for transferring application-specific user interfaces onto **PowerPlex**[®] Touch Panels.

In addition, you require a CAN bus cable for connecting the **PowerPlex**[®] components to the bus. Many manufacturers offer standard cables for this purpose. For more information on the required cable properties please see chapter 7 of the manual.

PowerPlex[®] reliably and precisely connects, regulates, controls and monitors electrical loads, switches and sensors via CAN. It controls status indications, operating conditions and execution of commands. Perfectly matched software and hardware components offer a comprehensive total solution with maximum potential of individualisation.

Each module protects the loads and cable harnesses against overcurrent. In addition the modules collect data of level sensors and temperature sensors as well as of shunts. Usually a **PowerPlex**[®] system consists of several modules of different kinds. The selection depends on the size of the electrical system to be monitored and controlled as well as of the current ratings of the loads.

Use our **PowerPlex**[®] Configuration Software in order to “programme” various control configurations. As requested, you can store them on the computer and load them into various **PowerPlex**[®] control systems. As soon as a **PowerPlex**[®] configuration has been completed, it will be transferred to the **PowerPlex**[®] modules (“nodes”) via the CAN bus interface. Via this CAN bus interface you also connect the **PowerPlex**[®] software for testing, analysing and debugging purposes of the **PowerPlex**[®] installation.

Fig. 3 shows the entire **PowerPlex**[®] product range to enable you to design your own **PowerPlex**[®] system solution:



Fig. 3: Overview of PowerPlex® components

More components required for setting up a **PowerPlex®** system are shown in Table 2.





| Accessories | Description |
|---|---|
|  | PowerPlex® Suite Configuration software for defining addresses, characteristics and functions of the PowerPlex® modules, assignment of the inputs and outputs to the modules and execution of system tests and analyses. |
|  | CAN-USB converter plus driver CAN-USB adapter for connecting the CAN bus hardware to the USB interface of the computer with the PowerPlex® configuration software and/or to the USB interface of a touch panel which could be connected to the PowerPlex® . |
|  | Terminating resistors Two 120 Ω resistors terminate the CAN bus network, one on each end of the CAN bus. |
|  | CAN bus cable A trunk CAN bus cable in pairs with two conductors (CAN-H and CAN-L) and the shield (SHLD) connect two PowerPlex® modules with each other. |
|  | Power supply 12 V DC or 24 V DC battery voltage supply |
|  | Line protection Protection of the L (+) connection from a PowerPlex® module to the battery or to the CAN bus. <i>Recommendation:</i> Thermal-magnetic E-T-A 8345 circuit breaker type. |

Table 2: Additional accessories

3. PowerPlex® system: General

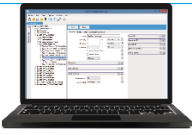
3.1. PowerPlex® Modules

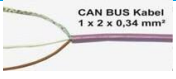
PowerPlex® modules are the key components of a **PowerPlex®** network. According to the CAN bus terminology they are the “nodes” of the network and form the points of switching, transmission and control.

PowerPlex® for DC system include high-end power semi-conductors with integral protective elements for switching and protection of electrical loads. The modules are free of mechanical components and thus unsusceptible to wear and shock and vibration resistant.

E-T-A offers various **PowerPlex®** modules for DC 12 V and DC 24 V systems. gives an example of the difference between two modules.



| DC Modules | | Mini Module MM300 | Power Module PM500 |
|----------------------|---------|---|---|
| | |  |  |
| Voltage ratings | | DC 12 V/24 V | DC 12 V/24 V |
| max. total current | | 12 A per module | 102 A per module |
| Inputs | digital | 8, configurable | 8 |
| | analog | | 4 |
| Outputs | | 8 (max. 1.5 A) | 4 (max. 1 A, dimmable) 6 (max. 8 A, FLPC) 2 (max. 25 A, FLPC) |
| Degree of protection | | IP22 | IP22 |
| Part number | | PP-M-MM300-000-0-Z-00 | PP-M-PM500-000-0-0-00 |

Table 3: Different PowerPlex® Modules

3.2. PowerPlex® CAN Bus

A **PowerPlex®** network can embrace up to 30 different **PowerPlex®** modules. The smallest **PowerPlex®** system would consist of two modules communicating via the CAN bus cable (see Fig. 4).

The loads controlled by the modules - in this case a light and bilge pump - are normally installed at some place in the vehicle which may not be necessarily close to the input signal. The decentralised control structure of **PowerPlex®** allows monitoring and switching of the devices anywhere on the vehicle or boat from any chosen installation site.

A level sensor monitors the bilge and supplies the analog information on module 1. From there the information is transferred to module 2 via the CAN bus. As soon as the measured analog input value (i.e. the “pumping level”) has exceeded a pre-set limit value, module 2 will send a switch command to the load (i.e. the “bilge pump”) so as to switch on the pump and to reduce the water level of the bilge back to an acceptable level. The status information of the bilge pump will be sent back to module 1 to switch on the display “bilge pump running”.

In addition, module 2 monitors the position of a light switch – ON or OFF – at one of the digital inputs and sends the switching signal to module 1, which switches the light ON or OFF depending on the switching status.

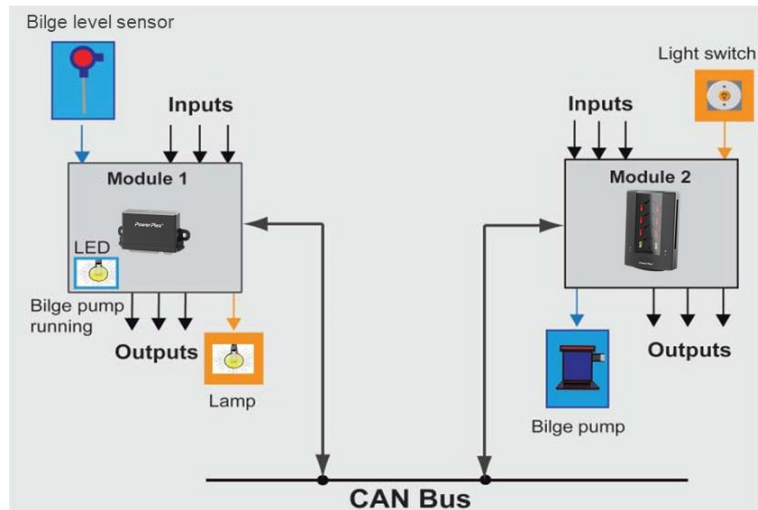

Fig. 4: Two PowerPlex® modules connected via CAN bus cable

An example demonstrates the principle of using the sensor and switching signal information at the module inputs as well as the sending, switching or the display of commands to the outputs of the same or a different module.

A typical **PowerPlex**® control system will of course connect a much higher number of modules and their inputs and outputs which will be distributed over the entire vehicle. Fig. 5 shows the electrical connection of several **PowerPlex**® modules in a serial CAN bus topology. Each module must be connected to the DC voltage supply and the CAN bus.

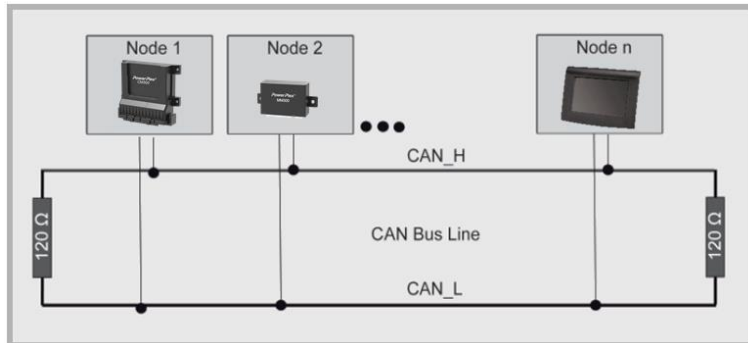

Fig. 5: Various PowerPlex® modules connected via serial CAN bus topology



Note

The first and last Modules of the CAN bus topology must be connected with a 120 Ω terminating resistor between the CAN high and CAN low signals. This helps avoiding interferences on the bus.

3.3. Put down the serial number

Each **PowerPlex**® component has a unique serial number. Before mounting the **PowerPlex**® modules, we recommend to prepare a list. This list should include: **PowerPlex**® component (module type), pertinent serial number and installation area.

You find the serial number of the **PowerPlex**® Keypad on the label attached to the housing. The serial number consists of 7 letters and numbers. It is used as an identification for new, not yet projected modules which have the CAN bus address “0” for a start. The serial numbers are required for system set-up. By means of the **PowerPlex**® configuration software the pertinent CAN bus addresses will be assigned.



Note

Please note the 7-digit serial number of each **PowerPlex**[®] component. It is required for the subsequent system configuration with the **PowerPlex**[®] configuration software.

Later, when you start configuring the modules and when you define their roles in the CAN network, the assignment between serial number, CAN bus address and installation area must be made.

The use of CAN bus address labels helps keeping an overview for module identification, above all in the event of comprehensive projects.

3.4. The CAN bus address

Any **PowerPlex**[®] component within a **PowerPlex**[®] network has its own, unique CAN bus address in a range of 1 to 30 for a clear identification. Assignment of the CAN bus addresses is during the system set-up by means of the **PowerPlex**[®] Configuration Software.

We recommend to mark the modules in the **PowerPlex**[®] system with the corresponding CAN bus addresses so as to be able to keep track.

4. General: **PowerPlex**[®] Keypads

Growing demands regarding safety and convenience lead to the installation of more and more electrical loads in vehicles and boats. With the **PowerPlex**[®] Keypads in Fig. 6 E-T-A offers another possibility of modern control of your **PowerPlex**[®] system.



Fig. 6: **PowerPlex**[®] Standard Keypads

By pressing the buttons, the user is able to operate all vital system conditions of the application. A keypad interacts via the CAN bus with at least one or more **PowerPlex**[®] modules.

Above all in special vehicles such as ambulances and fire brigades, input devices are required to send messages and visually indicate the status signals of the loads.

4.1. Technical data

The **PowerPlex**® Keypads should be cross-linked with at least one **PowerPlex**® module via a CAN bus. Table 4 summarizes important technical information.

| Technical Data | |
|--|--|
| Voltage ratings | DC 12 V/24 V |
| Operating voltage | DC 9 ... 32 V |
| Quiescent current | typically 10.2...11.3 mA at DC 24 V |
| LED current per button | blue: typically 6.6 mA at DC 24 V, 100% brightness green: typically 2.7 mA at DC 24 V, 100% brightness red: typically 5.5 mA at DC 24 V, 100% brightness |
| Degree of protection | IP53, from the front IP00, from the rear |
| Operating temperature | -20 ... +70 °C (-4 ... 158 °F) |
| Storage temperature | -30 ... +80 °C (-22 ... 176 °F) |
| Humidity (IEC 60068-2-30 Db) | 40 °C , 95% RH, 240 hours |
| Vibration (IEC 60068-2-6, Fc) | 10 Hz ... 57 Hz ± 0.38 mm 57 Hz ... 200 Hz acceleration 5 g |
| Shock (IEC 60068-2-27, Ea) | 25 g (11 ms) |
| EMC | CE marking to EN 61000-6-2, EN 61000-6-4 |
| Mass | series - 100 2-fold: 41 g 6-fold: 53 g 8-fold: 53 g series - 200 15-fold: 113 g |
| Interface | |
| CAN | PowerPlex CAN, 250 kbit/s, |
| The CAN terminals at each end of the bus have to be connected with a 120 Ω terminating resistor. | |
| Keyfields | |
| Size of frame | 15 x 15 mm ² , backlit |
| Illuminant | RGB Multi LEDs, configurable colour matching |
| Brightness | max. typically 400 mcd/button |
| Pushing force | 3.5 N |
| Typical life | min. 145,000 cycles |
| Foil | |
| Design | E-T-A Standard |
| Chemical resistance | alcohols, thinned acids, disinfectants (by Merz) to DIN 42115 |
| Symbols | Individual design available by means of slide-in foils (not included in the scope of delivery, dimensional drawings upon request) |

Table 4: Selection of technical data

*) For further information please see the relevant data sheet.

4.2. Scope of delivery

Standard scope of delivery of the **PowerPlex**[®] Keypad is without accessories.

For completion we recommend the following accessories:

- USB/CAN Converter: XPP-USBC0
XPP-USBC1 (opto-decoupled)
- Connection package: XPP-CP-120
(includes 4-pole connector housing, 4x crimp contact sleeves 20 – 24 AWG (0.22 – 0.5mm²))

5. Mounting

The **PowerPlex**[®] Keypads has been designed for stationary installation.



Note

This is an installation of class A. This installation may cause interferences in residential areas. In such a case the operator can be requested to carry out appropriate measures.

5.1. Installation check list

When planning and installing the **PowerPlex**[®] system please observe the limited number of system components. Our recommendation is some 30 **PowerPlex**[®] modules per system. Maximum values depend on the configuration scope so that more modules per system could be possible.

Mounting covers the following installation steps listed in :

| Step | Action |
|------|--|
| 1 | Application-specific system planning |
| 2 | Determine the installation site and prepare all necessary devices and tools |
| 3 | Put down the serial number |
| 4 | Run the cables |
| 5 | Prepare the necessary cut-outs for cables and device in the mounting plate |
| 6 | Connect the device for start-up |
| 7 | Mount and connect all remaining PowerPlex [®] components if not done before. |
| 8 | Start the system by switching on |
| 9 | Check the system behaviour by a complete system test |

Table 5: Installation check list

5.2. Recommended installation site

Basically, the installation site of all **PowerPlex**[®] components can be chosen totally freely. The **PowerPlex**[®] HMI devices should be installed in an area which offers maximum benefit for the user. The **PowerPlex**[®] modules on the other hand should be installed close to the connected loads to reduce wiring efforts.



Important

- Leave enough space for heat dissipation.
- Please make sure to install the **PowerPlex**[®] modules in enclosed rooms.
- Please observe the mounting version so as to reach the required degree of protection.

General requirements of installation site

When choosing the mounting site, various factors that might influence the performance of the device have to be considered. Table 6 gives you an overview of the major factors.





| | |
|---|---|
|  | Ventilation Please ensure sufficient ventilation by leaving enough space at all sides of the device and ensure that the vent holes are not blocked. Leave enough space between the devices. |
|  | Installation area Ensure a tight installation on the mounting area. Please consider the vehicle-specific properties and do not mount components in places where might affect the safety features of the vehicle. In addition, make sure that the mounting surface is flat and even and not too rough so as to ensure the requested protection degree. |
|  | Cable bushing Ensure installation at a site where the cables can be laid and connected properly. |
|  | Electrical noise pulses The installation site should provide sufficient distance to any devices that might emit noise pulses. |

Table 6: General requirement of the installation site

5.3. General notes on wiring

The selection of the correct cable types is important for the reliable power distribution, control and monitoring by means of a **PowerPlex**[®] system. Please ensure to use cables of superior quality with the suitable cross sections to avoid voltage drops. Please also see the separate chapter 7 concerning the integration of the device into the CAN bus network.

The cables should be laid very carefully to achieve the maximum performance of the **PowerPlex**[®] installation. The following gives general hints which must be observed regarding wiring of a **PowerPlex**[®] system and the connected loads.

| Item | Note |
|------|--|
| 1 | The cables should not be kinked or bent sharply. Please provide sufficient bending radii. |
| 2 | Cables must be protected against damages and heat. Avoid the proximity to moveable or hot parts and to machines. |
| 3 | Cables should be secured by means of brackets or cable clips. Excessive cable lengths should be disposed of appropriately. |
| 4 | Depending on the site of the cables, waterproof bushings might be useful. |
| 5 | Ensure a suitable strain relief. |
| 6 | Check cables with regard to intact insulation, above all after cable laying. |

Table 7: General notes on wiring

If AC and DC current is used for installation, an adequate insulation must be ensured.

| | |
|---|---|
|  | Note Please do not forget the 120 Ω terminating resistor when the PowerPlex [®] Keypads is connected as first and/or last participant on the CAN bus. |
|---|---|

5.4. Required installation dimensions - mounting cut-out

The **PowerPlex**® Keypads are meant for front panel mounting. The **PowerPlex**® Keypads are screwed onto the mounting plate from the front, e.g. in the side trim panel. The required dimensions are shown in Fig. 7.

The CAN bus cable as well as the supply cables are connected to the keypads from the rear by means of mating plugs. This must be considered in the planning stage and ensures ease of mounting, preventing a possible kinking of the cables.

Delivery of a standard **PowerPlex**® Keypad does not include any mating plugs. They can be ordered separately as accessories XPP-CP-120: Please order the corresponding bushing housings (4-pole) and the requested female pins (20-24AWG), see chapter 4.2).

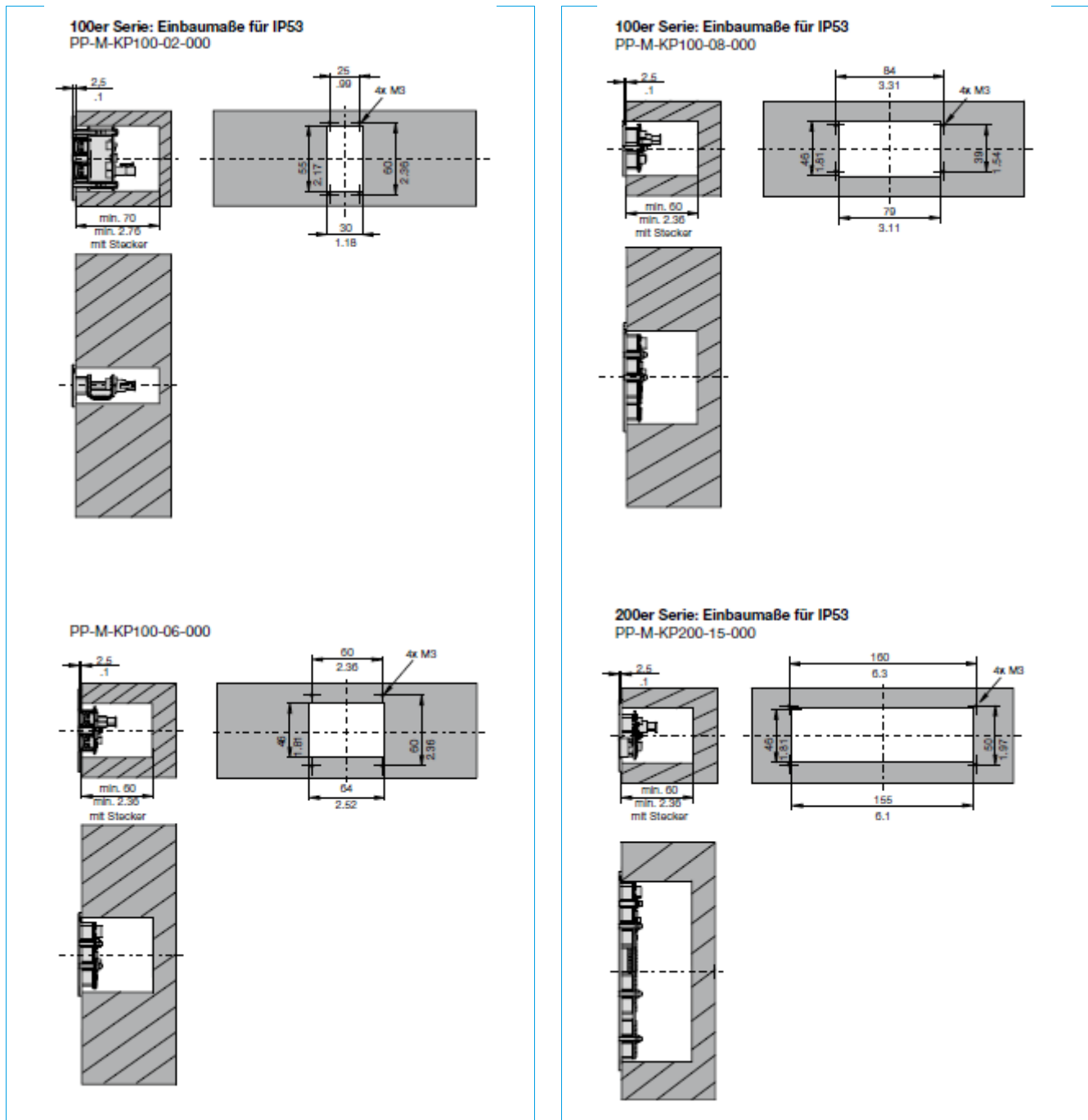

Fig. 7: Dimensions for the required mounting cut-out

5.5. Dimensions and space requirements

According to EMC conditions there must always be sufficient space between the different electrical devices. Space requirement of a device depends on its dimensions shown in Fig. 8.

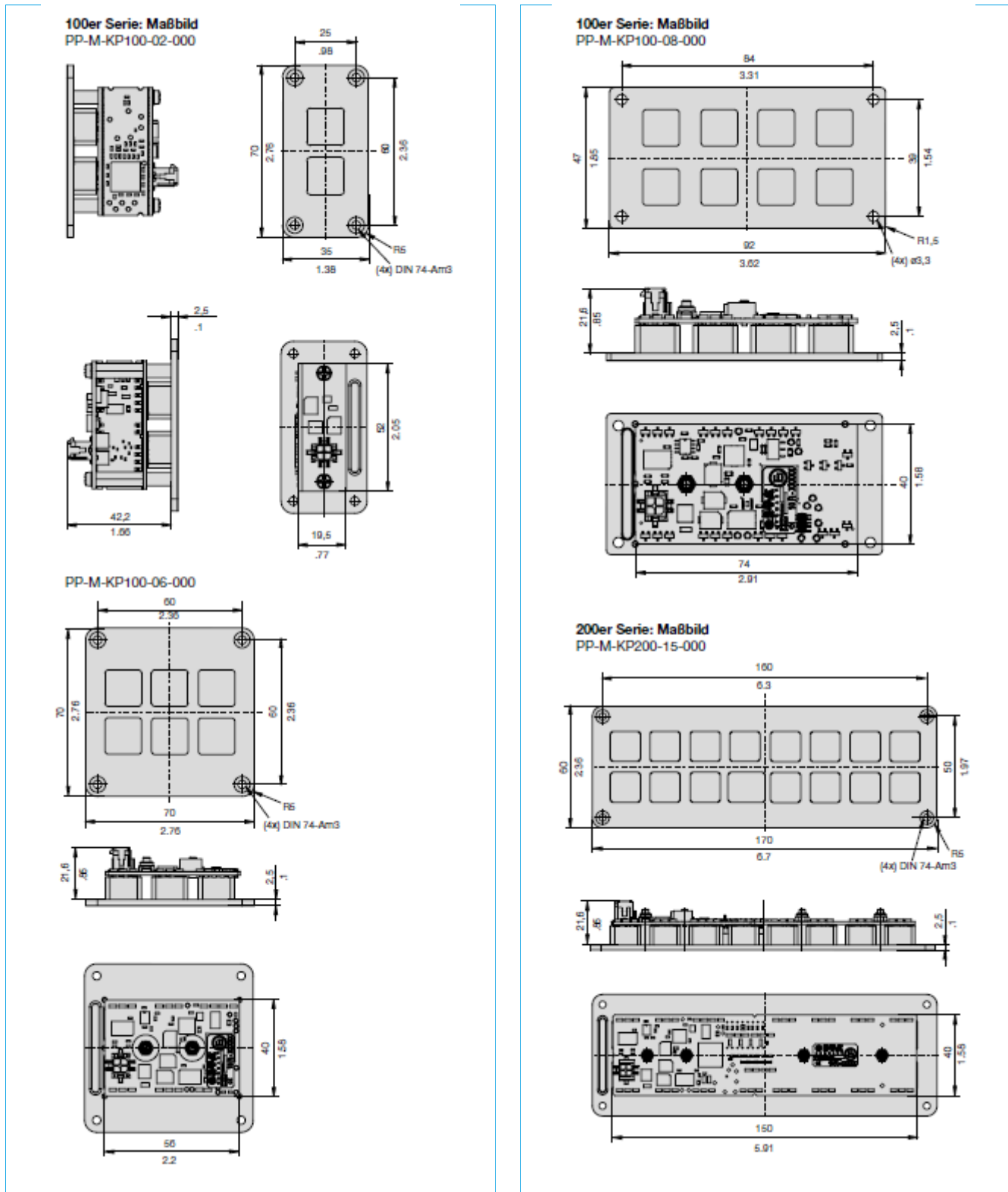

Fig. 8: Dimensions of the different PowerPlex® Keypads

5.6. Mounting of the device

Before you start installation, please make sure that

- the installation site was selected under consideration of the product-specific requirements
- the cable connections were identified correctly and cable laying was thoroughly planned
- the power supply was disconnected and protected against inadvertent reset

| Step | Action |
|------|---|
| 1 | Mark the intended installation site following the installation dimensions |
| 2 | Drill the mounting holes into the wall with an adequate tool. |
| 3 | Depending on the accessibility of the cable connections we recommend to connect all cables (current, CAN etc.) before mounting the device. Important: A cable connection must only be established if the main switch is OFF. Check the cables with regard to correct polarity and ensure that the max. permissible operating voltage is not exceeded. Please do not forget the terminating resistor if the device is the first or last participant on the CAN bus. |

Table 8: Mounting of the device

Pin assignment:

The pins of the **PowerPlex**® Keypads are on the bottom side. The pin assignment is shown in Table 9. Please note that the mating connectors are not included in the delivery scope as standard.

| Terminal | Interface | assignment | pin no. |
|--|--|------------|---------|
|  | PowerPlex ® CAN interface | CAN-L | 1 |
| | | CAN-H | 2 |
| | Power supply (DC 12V/24V; DC 9 ... 32V) | UBatt- | 3 |
| | | UBatt+ | 4 |

Table 9: Pin assignment on the 4-pole terminal

6. Marking of the keypads

The keypads are normally marked according application specification. On rear of every **PowerPlex**® Keypad there is a slot for a slide-in foil. We recommend to use foils that are max. 0.2 mm thick. The type of material can be freely selected.

Basically, any type of symbol can be used for marking the foils. The relevant standard DIN ISO 7000 “Graphical symbols for use on equipment” holds a great number of standardised symbols for various applications. Printing or marking on the keys must be done by the customer by observing the dimensions listed in Fig. 9.

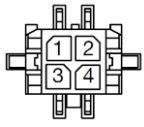
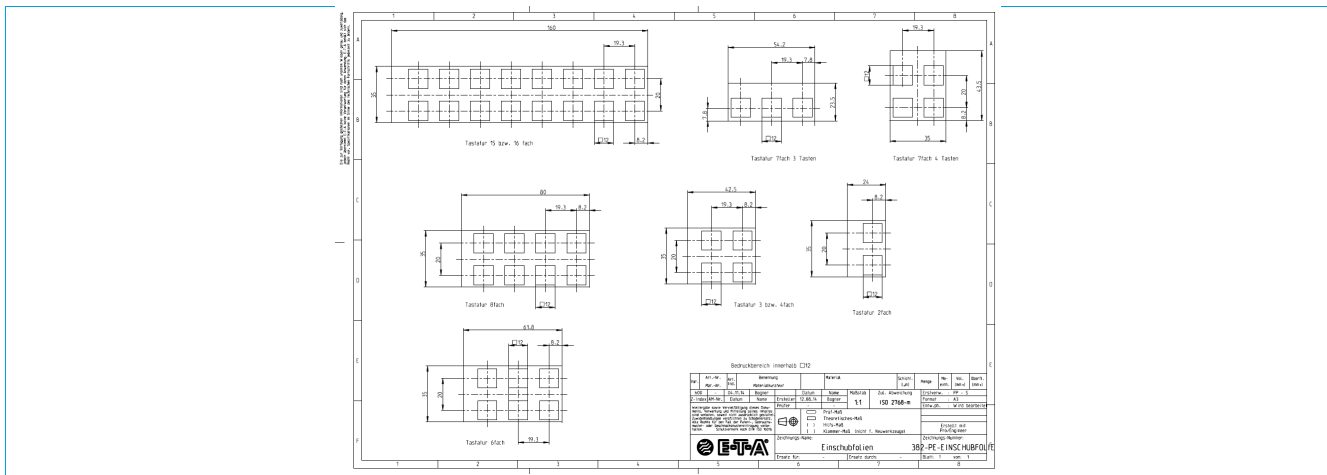

Fig. 9: Dimensions for creating a printing template
*) For a larger picture please see appendix

7. Integration of the device in the CAN bus network

To set up the CAN bus network all **PowerPlex®** components are connected with each other (→ Fig. 10).

A CAN bus must be closed at the beginning and the end with a 120 Ω resistor each. Bus terminating resistors are not installed in the Keypad. If a **PowerPlex®** Keypad is operated as first or past participant on a CAN bus, an additional 120-Ω-terminating resistor must be inserted between the pins 1 and 2.

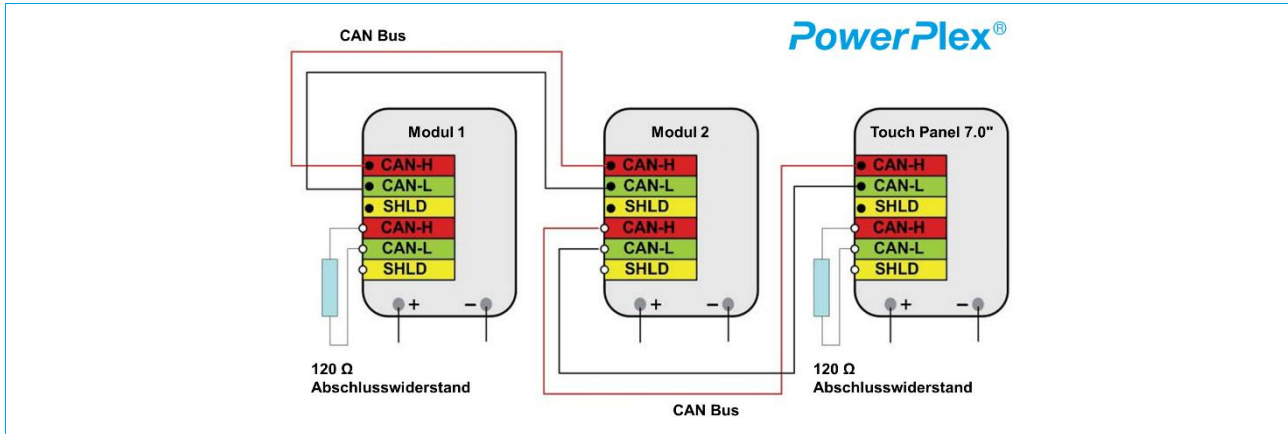

Fig. 10: Connection of the PowerPlex® components in the CAN bus system

A CAN bus cable typically is a twisted pair cable with two wires, CAN-H and CAN-L, and shield SHLD. Table 10 lists the major properties which the CAN bus cable to be used should have. They correspond to a typical CAN bus cable.

| Mechanical properties* | |
|------------------------------------|---|
| Diameter - inner conductor | 0.97 mm |
| Nominal cross section | 0.5 mm ² |
| Conductor material | copper, blank |
| Structure of conductor | multi-stranded copper conductor |
| Number of cores | 2 |
| Total shield | Tinned copper braiding |
| Core colours | CAN-H white CAN-L: brown |
| Outer diameter of cable | 7.0 mm |
| Colour of overjacket | purple |
| Mass | 69 kg/km |
| Min. bending radius | laid out: 90 mm static: 48 mm |
| Operating temperature | -40 °C ... +70 °C (-40 ... +158 °F) |
| Electrical properties* | |
| Surge impedance | 120 Ω |
| Conductor resistance | 37 Ω/km max. |
| Insulation resistance | 1 GΩ/km |
| Test voltage | 1.5 kV |
| Other properties* | |
| Resistance against ambient effects | UV resistant, weatherproof, oil-resistant, coolant-resistant, microbe-resistant |
| Mechanical strength | abrasion-proof, notch-resistant, low adhesion |
| Chemical resistance | acid- and alkali-proof |
| Thermal resistance | thermal load: 1.09 MJ/m |

Table 10: Major properties of the CAN bus cable to be used

*) Fa. Helukabel: CAN.BUS 1X2X0.50, www.helukabel.de

**Caution**

Please make sure that beginning and end of the CAN bus network are closed off with a 120-Ω resistor, i.e. both the first and the last **PowerPlex**[®] component must have a 120-Ω terminating resistor. This is of major importance for the correct and reliable function of the **PowerPlex**[®] installation.

**Note**

The terminating resistors are not included in the scope of delivery. They can be ordered separately as accessories.

8. Connection to power supply

After interconnecting all **PowerPlex**[®] components of your system via a CAN bus cable, the installation only must be connected to electrical power supply. **PowerPlex**[®] is suitable for DC 12 V or DC 24 V.

**Important**

- Please make sure that all electrical installations were carried out in accordance with EN ISO 10133.
- Please make sure that the power supply is disconnected and protected against inadvertent re-connection during the works on the system.
- Please avoid big differences between the lengths of the (+) and (-) cables.

Connecting the device

The pins 3 and 4 of the 4-pin connector are used for connecting the **PowerPlex**[®] Keypads to the power supply (DC 12 V/24 V). A mating plug provides ease of connection.

**Important**

The device must be directly connected with the power supply via a suitable overcurrent protection. It must not be linked up within the system via some other **PowerPlex**[®] component to ensure impeccable start-up of the entire system.

9. PowerPlex® Configuration Software

The **PowerPlex®** Configuration Software is a part of **PowerPlex®**. The software is listed in the data sheet under “accessories”.

When order your **PowerPlex®** components, please verify if the configuration software is required or not. Possibly you already have the software from an earlier **PowerPlex®** project. You can also download the configuration software form our E-T-A website.



Note

The **PowerPlex®** Configuration Software is not automatically part of the delivery of **PowerPlex®** components. It is available for download on our E-T-A website.

9.1. Computer Requirements

The **PowerPlex®** analysis and configuration software runs on any computer or laptop running with a Windows® operating system. Please check your computer regarding the following requirements (Table 11).

| Technical data | |
|------------------------|---|
| Operating system | Windows®, Windows® XP |
| processor | Pentium III or higher |
| RAM | minimum: 256 MBytes recommendation: 512 MBytes |
| hard disk storage unit | minimum: 500 MBytes |
| screen resolution | minimum: 500 MBytes |
| input device | mouse or similar |
| Interfaces | USB 2.0 |

Table 11: Requirements of the configuration PC

| Step | Action |
|------|---|
| 1 | Check if the hard disk of the computer provides sufficient disk space |
| 2 | De-install previous versions before installing a new version of the PowerPlex® Configuration Software on your Windows®-based computer (→ chapter 9.2, Software installation) |



Note

You require admin access rights for installing the **PowerPlex®** Configuration Software.

9.2. Software installation

The **PowerPlex®** Suite can directly be downloaded from E-T-A's Website. A username and a password are required which will be assigned upon request. On demand the configuration software can also be made available on a USB flash drive. No further entries are required during the installation process. The **PowerPlex®** Suite can also be started from a USB flash drive.

10. CAN/USB converter and driver

For transmission of a complete or modified **PowerPlex**[®] configuration to a **PowerPlex**[®] Keypad and other **PowerPlex**[®] hardware, you must connect your configuration PC with the **PowerPlex**[®] network (CAN bus). The following USB/CAN adapters are supported by the **PowerPlex**[®] software: CAN/USB-light adapter von Sontheim, PEAK USB, PEAK PC.



Fig. 11: CAN/USB converter (example: Peak)



Note

The driver of the selected CAN/USB adapter must also be installed on the configuration PC.

11. Important information and safety instructions

The following table lists various information and safety instructions for start-up and use of the module.







| | |
|---|---|
|  | Warning: Installation and operation of the module This device must be installed and operated in compliance with the given instructions. Failure to observe the instructions can cause personal injury, damages of the boat or vehicle or reduced operational performance. |
|  | Warning: Switch off main switch Before starting installation, the main switch of the boat or vehicle has to be switched off. A cable connection must only be established if the main switch is OFF. |
|  | Warning: Possible ignition hazard The device must NOT be used in inflammable surroundings. |
|  | Warning: high voltage The cover must NEVER be opened. Access to the inner components is not allowed unless indicated otherwise in this manual. |
|  | Caution Grounding The device must be grounded before switching on. |
|  | Caution Water ingress Disclaimer of warranty in the event of water ingress. Waterproofness of the module depends on the correct installation. E-T-A does not accept any liability in this case. |

Table 12: Important information

EMC installation directives

The **PowerPlex**[®] hardware and accessories comply with the EMC directives. Thus electromagnetic interferences between the devices are avoided which would otherwise affect the system performance. A professional installation is mandatory. To ensure the best EMC conditions, the widest possible distance between the different electrical devices should be applied.

Technical accuracy

All technical data in this manual were correct in all conscience at the time of printing. E-T-A cannot be held liable for any (inadvertent) errors. Due to continuous product improvements at E-T-A there could be discrepancies between the actual product and the manual. Product changes or amendments of the technical specifications will be carried out without prior notification. The latest versions of the **PowerPlex**[®] manuals are available on our website (www.e-t-a.de).

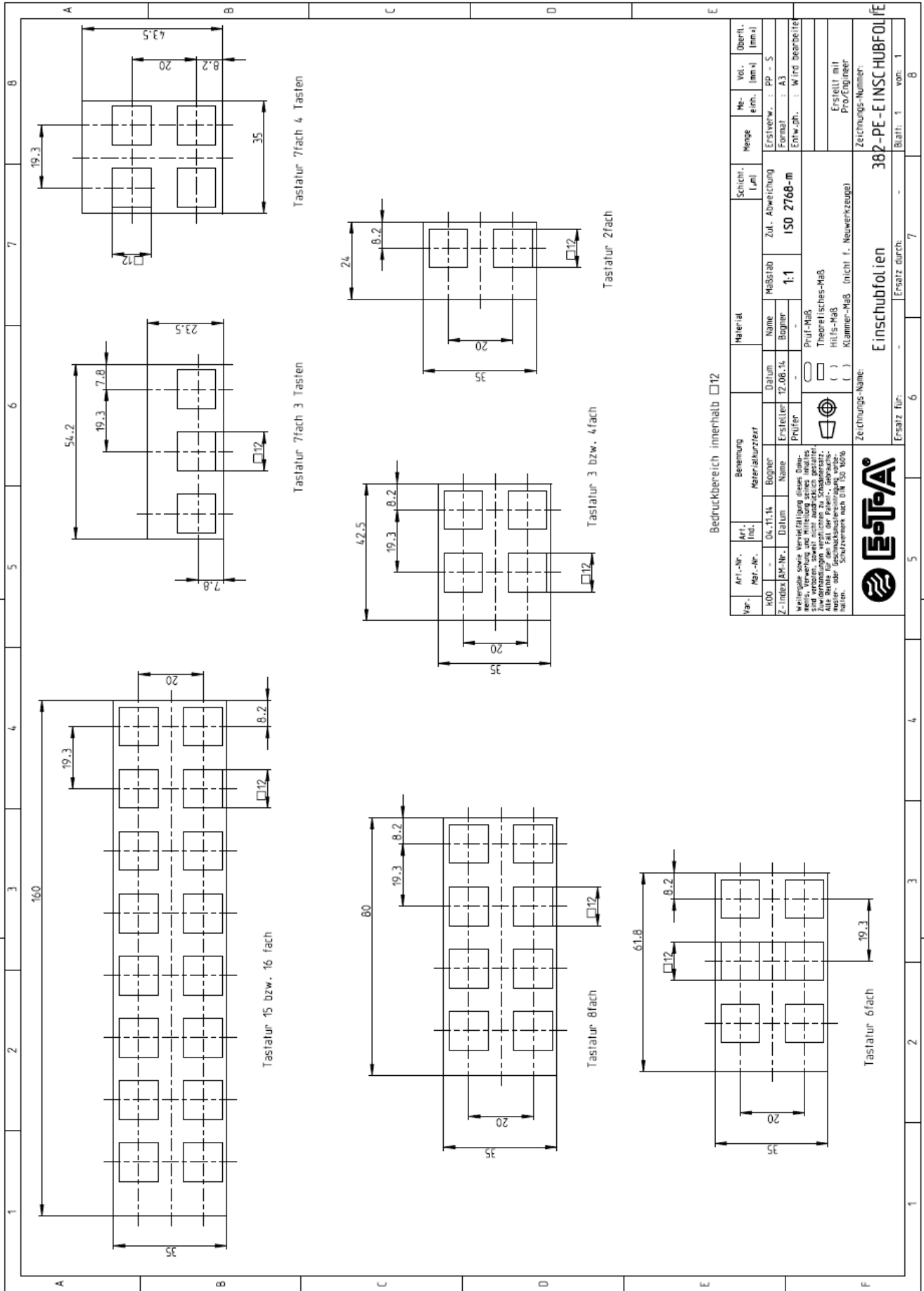



Installation Instructions: **PowerPlex**[®] Key pads
Release: I_PP-M-KP-E – Index: A
Release Date: 12/2020
All rights reserved



E-T-A Elektrotechnische Apparate GmbH
Industriestraße 2-8 · 90518 Altdorf /
GERMANY
Tel. 09187 10-0 · Fax 09187 10-397
E-Mail: info@e-t-a.de www.e-t-a.de